

OPERATING INSTRUCTIONS PC1 HOIST

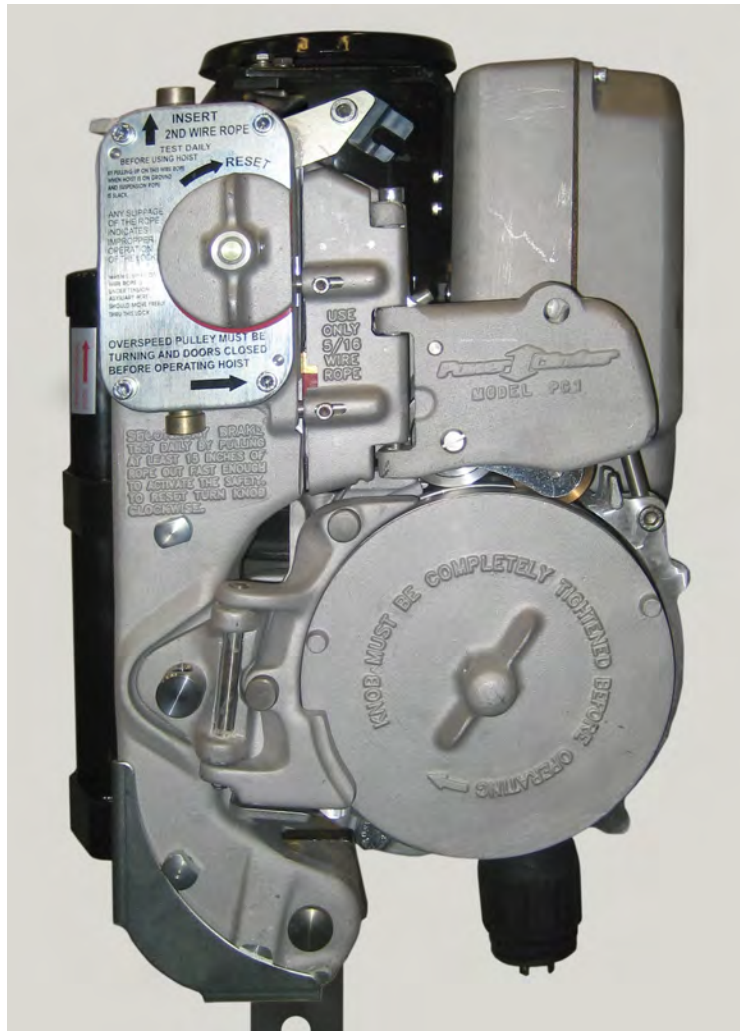

WARNING:

- **All persons** operating this equipment must read and completely understand this manual
- **All persons** must be thoroughly trained in the use of the equipment, its operational and safety features, and they must also be capable of carrying out the daily inspections.
- Only authorized persons shall operate the equipment.
- Any operation in violation of these instructions is at the **operator's own risk** and **may result in serious injuries**.
- Keep this manual with the hoist at all times.
- Use only spare parts and recommended steel wire rope from Power Climber®.
- It is the responsibility of the user of this hoist to determine that this hoist is suitable to be used in conjunction with any other equipment. The user must also determine that this hoist and additional components used will be in strict conformity with the provisions of Federal, State, National, and local ordinances and regulations.

Manufacturer

Power Climber
A Division of SafeWorks, LLC
365 Upland Drive
Seattle, WA 98188

Customer Support (North America)

Tel: +1 800 560 2546 (CLIMB)
or outside the U.S.: +1 206 577 0101
Fax: 1 866 470 8722
Email: CustomerService@PowerClimber.com
Web: www.PowerClimber.com

Table of Contents

1.0 Introduction.....	4
1.1 Features.....	4
2.0 Instructions.....	6
2.1 General Specifications.....	6
2.2 Hazard Symbol Summary.....	6
2.3 Safety Summary.....	7
2.4 Hazard Summary.....	10
Mechanical Hazards.....	10
Electrical Hazards.....	11
Environmental Hazards.....	11
Hazard Prevention.....	11
Wire Rope.....	11
2.5 Hoist Components.....	15
Front View Of Hoist.....	15
Side And Back Views Of Hoist.....	16
2.6 Hoist Installation.....	17
Installing Hoist To Platform.....	17
Laying Down The PC1 Hoist.....	18
Reeving Main Suspension Wire Rope.....	19
Breech Loading Wire Rope.....	20
Reeving Secondary Wire Rope (Optional).....	22
3.0 Safety Instructions	23
3.1 Daily Tests.....	23
Testing Overspeed Brake.....	23
Testing Overspeed Brake Test Button.....	24
Resetting the Overspeed Brake.....	25
Testing the Emergency Stop Button.....	25
Testing the Controlled Descent Feature.....	26
3.2 Daily Inspection.....	27
4.0 Hoist Operations.....	27
Testing the Emergency Stop Button.....	28
4.1 Cold Weather Operation.....	29
4.2 Dereeving.....	29
Removing the Main Suspension Wire Rope.....	29
Removing the Secondary Wire Rope (Optional).....	30
4.3 Maintenance.....	31
4.4 Troubleshooting.....	31
4.5 Hoist Labels.....	35
5.0 Code Of Safe Practices.....	36

1.0 INTRODUCTION

The PC1 is used to raise and lower suspended scaffolds, work cages, and bosun chairs on, or in buildings and structures. If used for any other purpose, you must take all necessary precautions to be sure that both design and operation are hazard free, and such use conforms with manufacturer's specifications.

Before using the PC1, learn the procedures described in this manual. Any operation in violation of these instructions may result in bodily injury or death. The design and manufacturing of the PC1 must comply with UL1323 standard and CUL (CAN/CSA -Z271-98). The use of the PC1 within the United States is governed by OSHA CFR 29. Consult OSHA CFR-1926 for temporary applications and OSHA CFR 29-1910 for permanent applications.

It is the duty of the employer to provide this manual to each operator.

Power Climber reserves the right to make changes or modifications to its hoist. Users of this equipment must request current operating information prior to using this equipment. Call your local Power Climber dealer.

This manual is included with each PC1. Additional copies are available from your Power Climber dealer. Keep a current copy of this manual with the hoist at all times.

1.1 FEATURES

Standard Features of the PC1 Hoist		
Feature	Function	Benefit
Broad Operating Range: 208V, +10%/-15%	<ul style="list-style-type: none"> Significantly improved performance at low voltage Proven reliable performance from 177 to 229 run volts Tested in 30 min. continuous run tests 	<ul style="list-style-type: none"> Reduces service calls Extends electric component life Eliminates power-induced down time Allows longer drops with yoked hoists
220V, +/- 10%	<ul style="list-style-type: none"> Proven reliable performance from 198 to 242 run volts Tested in 30 min continuous run tests 	<ul style="list-style-type: none"> Saves time and money (\$)
Load Sensitive Traction	<ul style="list-style-type: none"> Applies only the traction needed to lift load, not full 1,000 lbs. lifting force on rope Virtually eliminates the risk of wire rope jam 	<ul style="list-style-type: none"> Greater tolerance of wire rope condition Saves wear and tear on rope, extends wire rope life Saves costly wire rope jam in field Minimizes the need for rescue Minimizes wire rope destruction and lengthy service





Standard Features of the PC1 Hoist		
Feature	Function	Benefit
Voltage Indicator	<ul style="list-style-type: none"> Indicates voltage to unit 	<ul style="list-style-type: none"> Easy visual inspection can eliminate a service call Technician can diagnose voltage problem by phone
Remote Ready	<ul style="list-style-type: none"> Built-in pendant port accepts plug-in remote control Compatible with 8-0281 series remotes 	<ul style="list-style-type: none"> No need to drill and wire remote into hoist Leaves hoist mounted controls operable
Built-in Overspeed Brake	<ul style="list-style-type: none"> Stops hoist in overspeed condition Cannot be left behind in shop, bypassed, or dismantled 	<ul style="list-style-type: none"> Ensures greater operator safety Improved reliability
Controlled Descent	<ul style="list-style-type: none"> Allows downward travel at a controlled rate of speed in the event of power loss 	<ul style="list-style-type: none"> Eliminates need for rescue Allows self-rescue
Built-in Secondary Wire Rope	<ul style="list-style-type: none"> Allows use of secondary suspension wire rope for required applications (double deck, overhead protection, some industrial applications) or eliminate independent safety lines. Designed to mount into hoist for maximum durability and security 	<ul style="list-style-type: none"> More versatile hoist ready for any application Eliminates possible loss/damage because it is built-in, rather than added on Saves money because it is less expensive than other manufacturers.
Optional Features of the PC1 Hoist		
Feature	Function	Benefit
Overload Device (mounted on suspended scaffold)	Allows to be shop set to 750 lbs or 1,250 lbs. Refer to overload instructions.	Reduces rigging material & labor. Also required for PC1 hoists used in Canada.



2.0 INSTRUCTIONS

2.1 GENERAL SPECIFICATIONS

Motor type	PC1-1000E	PC1-1000A	PC1-1000E3	PC1-1000 EDV
Working Load Limit (WLL lbs)	1000	1000	1000	1000
Speed (ft / min)	35	Up to 35	35	35
Weight (lbs)	102	88	102	104
Voltage	208 or 220 VAC 1 PH	90-120 PSI	208/240 VAC 3PH	220/110 VAC 1 PH
Current	7.5 A @ 208 V or 9 A @ 220 V	40-70 CFM	6 A	7 / 14 A
Circuit breaker	20 / 30 A	N/A	20 / 30 A	20 / 30 A
Dimensions (H x W x D) (inches)	20x13x12	18.5x14.12	20x13x12	20x13x12

2.2 HAZARD SYMBOL SUMMARY

Symbol	Term	Meaning
	STOP	Stop action and follow instructions before continuing
	WARNING	Warns against possible immediate death or serious injury
	CAUTION	Warns against possible injury
	ELECTRICAL HAZARD	Warns against possible electrical shock hazard

Symbol	Term	Meaning
	READ	Must read this before performing any action that follows
	NOTE / TIP	Remember and take this into account
	SAFETY GEAR	Mandatory use of safety gear

2.3 SAFETY SUMMARY

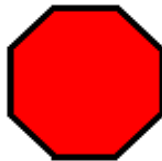

Every year workers on suspended scaffolds are injured, become disabled, or are killed because of carelessness or because they did not understand how to correctly operate the equipment. Do not become one of them. Know how to use this equipment and prevent accidents.

NEVER operate equipment that you DO NOT understand. You may cause accidents, resulting in injury or death to you or people around you.

This instruction manual is not all inclusive. It is impossible to anticipate every possible way this equipment may be used and all possible hazardous situations. It is very important that you determine for yourself whether the equipment is safe. You must understand the operating characteristics of this hoist. You must understand how the hoist will operate in your application. You must be certain not to put yourself or others in danger, or cause damage to property or other persons. Call your hoist supplier if you have any questions concerning this equipment.

1. Read and understand this manual **BEFORE** using this equipment.
2. Use the Troubleshooting Guide in this manual to solve problems that may develop with the hoist. Repairs must only be made by people trained and authorized to do so. **NEVER** maintain or repair the equipment while the unit is suspended (above ground level).
3. Be careful when operating the hoist in freezing temperatures. Water or moisture may enter the hoist's overspeed brake or traction assembly. See Cold Weather Operating Instructions in this manual.
4. Do not remove any parts from the hoist without replacing them. Do not change or substitute any approved hoist parts for parts that do not meet manufacturer's specifications. Do not modify this hoist without prior approval from Power Climber. Modifications can put you in danger if not done correctly. Making modifications can also void any manufacturer's warranty and make you liable for any modifications.
5. **WARNING!** Do not use suspended scaffolds unless:
 - A. You are wearing a personal fall arrest system that meets or exceeds your application requirements.
 - B. You have personally made sure of the following:
 - i. The roof support system is complete, properly assembled, counterweighted (or otherwise anchored), tied off, and not overloaded.
 - ii. Hoists and platforms are not overloaded.
 - C. The wire rope is free of defects and is the size and type specified for the hoist.
 - D. Guardrails and toe boards are properly installed.
 - E. The main suspension wire rope is vertical.

Setup and use must comply with Power Climber instructions, OSHA, CSA, and other applicable codes.

6. Do not reset the overspeed brake until you have first read and completely understand the Troubleshooting Guidelines in this manual.
7. Do not use visibly worn, kinked, bird-caged, undersized, or damaged wire rope. Protect wire rope from sharp or abrasive edges of building. Do not use wire rope that has been exposed to fire, excessive wear, corrosive atmosphere, chemicals, passage of electric current, or temperatures above 200° F (93.3° C).
8. Inspect the wire rope before rigging. Handle, inspect, and maintain wire rope carefully during and after each job. Lubricate the wire rope according to the manufacturer's recommendations.

9. When welding from a suspended scaffold, provide proper electrical grounding for this hoist.
 - A. When welding from a suspended scaffold: (Within the US reference OSHA CFR 29-1926.451(f)(17)
 - B. Make sure platform is grounded to the structure.
 - C. Insulate wire rope 4 ft (1.2 m) above and below the platform.
 - D. Insulate wire rope at suspension point and assure that the wire rope cannot contact the structure along its entire length, including the tail line.
 - E. Cover the hoist with an insulating material.
10. Never operate an electric hoist in an explosive atmosphere such as a refinery, chemical plant, grain elevator, distilleries, ship or silo interiors, mines, around coal handling equipment, or around explosive organic vapors or dust.
11. Never use hoists and aluminum platforms around caustic materials, acids, or acid fumes. Use hoist covers when corrosive materials are present.
12. Maintain clearances and make sure no obstructions interfere with vertical travel.
13. Avoid power lines. Make sure the platform or hand tools cannot swing or be blown within 10 ft (3 m) of a power line. Never, under any circumstances, rig a platform above electrical power lines.
14. Push the operating switch by hand only. Do not use foreign objects to operate the hoist.
15. When not in use, store hoist and stage to protect from unauthorized use. Cover the hoist if possible. Always unplug power cord when not in use and equipment is not attended.
16. Do not allow anyone under suspended equipment. If necessary, provide protection below the suspended equipment to prevent injury to people from falling objects. Use lanyards to secure tools materials from falling on personnel below.
17. Use approved personnel harnesses, lanyards, rope grabs, and independent lifelines at all times. Attach the lifelines to a structural member of the building, never to part of the rigging unless specifically designed for this purpose.
18. Comply with all local, state, and federal safety codes and equipment instructions.
19. Only authorized and properly trained personnel shall operate this hoist. Each operator must determine his own fitness to operate this hoist. Consult your doctor if you are in doubt. Each operator must not be under the influence of alcohol or drugs.
20. If you hear any strange noises or if the hoist does not appear to work normally, stop using it immediately. Do not continue to use the equipment until it is repaired.

2.4 HAZARD SUMMARY



WARNING

If the hoist is suspended in the air and the motor is running, but the wire rope does not move through the hoist, STOP the hoist immediately! Damaged wire rope may be jammed inside the hoist. Any attempt to move the hoist up or down could damage the equipment or cause injury or death.

There are many hazards when working on a suspended scaffold. The following are common hazards. The list is not complete. It is provided to increase safety awareness on the job site.

MECHANICAL HAZARDS

- **Crushing** between the platform and the building.
- **Cutting or severing** between moving machine parts.
- **Loss of rigging stability** because of one or more of the following:
 - Insufficient counterweight or counterweights not properly fixed
 - Inadequate mechanical strength
 - Increase in vertical load on suspension wire because the platform encounters an obstacle, the platform overloads, or the suspension wire rope breaks
 - Platform catches on overhang when going up
- **Falling**
 - from the platform when working
 - by using a wire rope that is too short
 - if the platform is not strong enough for the weight and breaks
 - if wire rope or platform interconnections fail
 - rigging failure can cause falling
- **Idling and Slipping** due to loss of traction.
- **Jamming** due to damaged wire rope
- **Slip, trip, and fall hazards.** Pay attention to:
 - Decking, sides, guard rails, and toe boards on the platform
 - Control of platform level.
 - Safe access to the platform
 - Safe access to the wire rope anchorage points.
- **Falling Objects**
 - Decking and toe board spacing and orientation
 - Special requirements for operating a platform around the general public.



ELECTRICAL HAZARDS

- Failure of the electrical supply may delay travel of the platform
- Control system failure can cause unwanted movement of the platform
- Improper power supply (voltage or frequency) may damage the hoist

ENVIRONMENTAL HAZARDS

- Consider and prepare for the effects of climate. (Heat/Cold/Ice/Wind)
- Sandblasting and acid wash procedures may introduce special concerns. They may affect the immediate health of an operator and may pose serious risks to the hoist and other equipment being used.



HAZARD PREVENTION

- All electrical connections must be locked and supported by strain relief devices.
- Make sure the electrical cord and wire rope are long enough to allow full travel of the suspended equipment.



WIRE ROPE

<u>GENERAL SPECIFICATIONS</u>	
Wire Rope Diameter	5/16" 8mm, or 8.4mm
Wire Rope Specification	6x19, 6x31, or 5x26 compacted, Seale, Right Regular Lay, IPS (Improved Plow Steel), preformed wire rope with bright or galvanized finish. User must verify that the wire rope meets or exceeds applicable codes for breaking strength safety factor. US temporary applications require 6:1. Both Canadian and permanent applications require 10:1.

1. Wire rope requires lubrication under normal conditions. Lightly lubricate it with a wire rope lubricant specified by the wire rope manufacturer monthly or more often if necessary.
2. To prepare the end of IWRC wire rope for insertion, cut back the steel center at least 2 in (51mm) to allow for independent movement of the core. Braze and rough shape the end of the wire rope to form a smooth, tapered, bullet shape no more than 1/4-in. (6.4mm) long. DO NOT cool the end of the hot wire rope in water or oil. This makes the end brittle and may cause it to break off. Oil the bullet after it cools to prevent rusting. (Fibercore wire rope only needs to have the bullet prepared, there is no reason to cut back the center of this rope.)
3. Always uncoil and carefully examine the wire rope before use. Worn, kinked, bird-caged, or damaged wire rope cannot be repaired. It must be replaced.

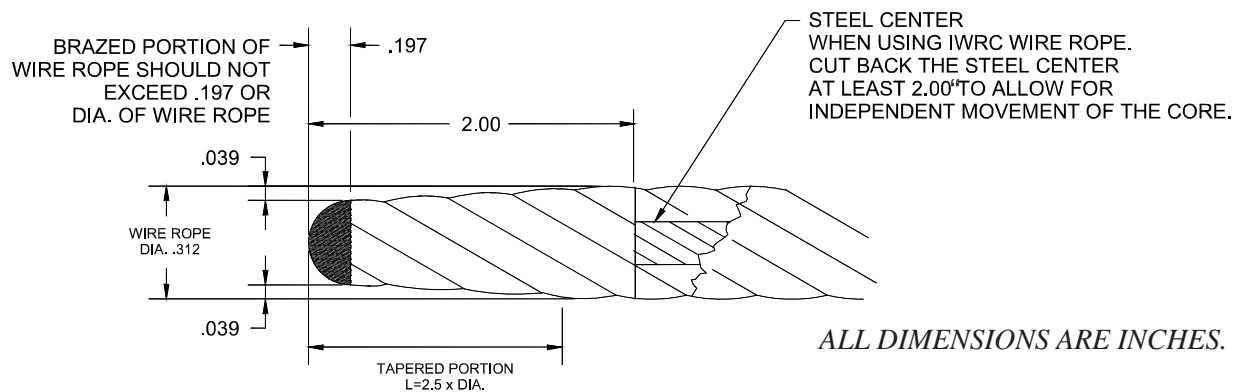

4. Use a heavy-duty thimble for the main suspension wire rope and follow the manufacturer's requirements for termination of the wire rope hardware that you are using.

WARNING

Wire rope stretches when loaded. The diameter is reduced. Always inspect the wire rope termination and refer to the manufacturer's inspection procedures.

5. Be sure there is enough wire rope to reach the lowest possible point of travel.
6. Wire rope begins to wear the moment it is used. It must be regularly inspected to be sure it is in good condition. Wire rope must be removed from service when diameter loss or wire breakage occurs as listed within ANSI A10.4

WARNING:



Use protective gloves to handle the steel wire ropes

Use only Power Climber-approved steel wire rope. Steel wire ropes must be replaced in any of the following conditions:

- More than 10 wires are broken on a length of 1 inch (240mm) long
- Excessive corrosion
- Damage due to heat
- Reduction of the nominal diameter by more than 10%
- Kinking (1), crushing (2), bird caging (3) or any other distortion of the wire rope structure.

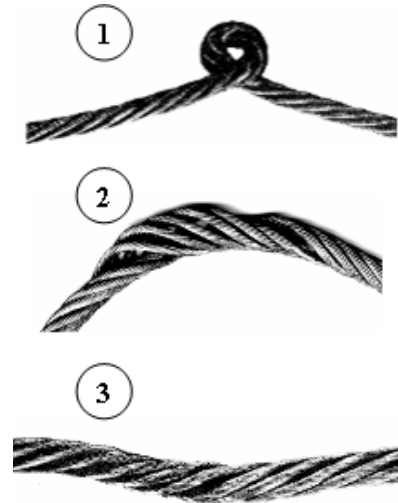

WIRE ROPE INSPECTION PROCEDURE

The need for replacement of suspension wire ropes shall be determined by regular inspection and shall be based on the condition of the wire rope inspected. Wire rope in active service should be visually inspected once every working day. A thorough inspection shall be made once a month or before each use if the suspension wire ropes have been inactive for 30 days or longer and are placed into service. Dated and signed monthly reports of that inspection must be kept, indicating the condition of the ropes.

Any of the following conditions, or combination of conditions, shall be considered as sufficient reason for the removal of the wire rope from service:

CAN/CSA - Z271 7.7.4.1

Wire rope with one or more of the following defects shall be removed and replaced immediately.

1. Whenever there is severe corrosion. Any development of slight corrosion shall be noted and watched closely;
2. Whenever there are broken wires, as follows:
 - (a) When there is more than one valley break. A valley break is a wire break occurring in the valley between two adjacent strands.
 - (b) Whenever there are six randomly distributed broken wires in one rope lay or three broken wires in one strand in one rope lay. A rope lay is the length along the rope in which one strand makes a complete revolution around the rope.
3. Whenever there are broken wires in the vicinity of attachments. If this condition is localized in an operating rope, then the section in question may be eliminated by making a new attachment. This may be done rather than replacing the entire rope.
4. Whenever there is abrasion, scrubbing, flattening, or peening causing loss of more than one-third of the original diameter of the outside wires.
5. When there are severe kinks, crushing, birdcaging, or other damage resulting in distortion of the rope structure.
6. Whenever there is evidence of any heat damage resulting from a torch or caused by contact with electrical wires; and when the reduction from nominal diameter of the rope is:
 - (a) more than 1.2mm (0.047 in) for diameters up to and including 20mm (0.78 in)

- (b) 1.5mm (0.059 in) for diameters 22 to 28 mm
- (c) 2.5mm for diameters 32 to 40mm.

If it is not possible to lower the platform to the ground, secure the tail line* to prevent the platform from running off the suspension ropes. Consult a safety professional before rigging in such an area

*Tail line with loop termination



NOTE: Do not expose the wire rope to fire, temperatures above 200°F (93.3°C), passage of electrical current, or corrosive atmospheres and chemicals. This exposure will make the wire rope unsafe.

Acids will corrode and reduce the strength of both the inner and outer strands. When using corrosive chemicals, discard the wire rope after completing the project, or sooner if any damage is evident. Do not save wire rope that has been in contact with corrosives. When in doubt, replace the wire rope.

2.5 HOIST COMPONENTS



FRONT VIEW OF HOIST

1. Secondary wire rope insertion point
2. Main Suspension wire rope insertion point
3. Overspeed brake reset knob
4. Slack rope lever and inlet guide
5. Overspeed access door
6. Overspeed inspection port
7. Overspeed sensor wheel (with red stripe)
8. Frame
9. Diverter cover
10. Tail line guide
11. Traction roller assembly
12. Sheave guard
13. Traction sheave (under sheave guard)
14. Stirrup bar

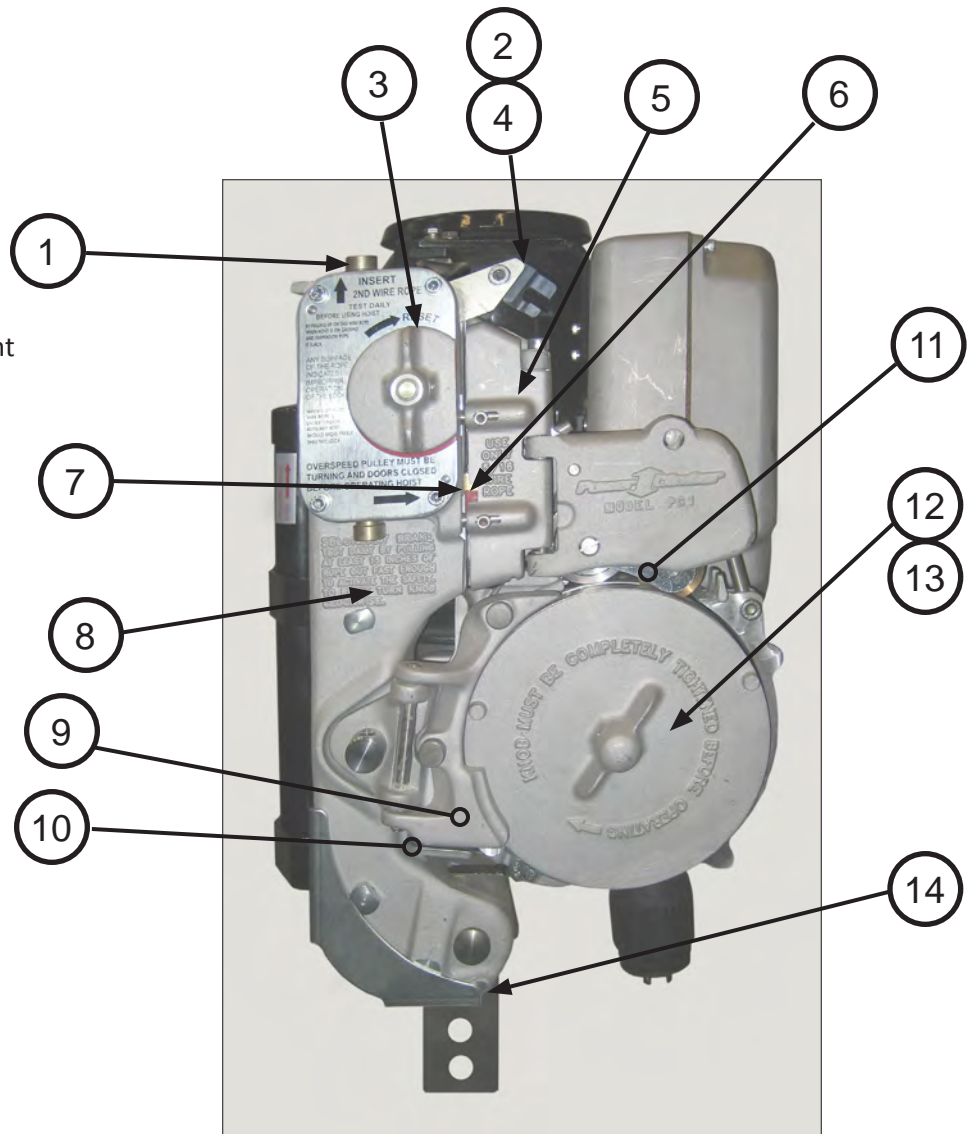



SIDE AND BACK VIEWS OF HOIST

1. "No Power" Emergency descent lever
2. Load lock
3. Manual secondary overspeed brake button

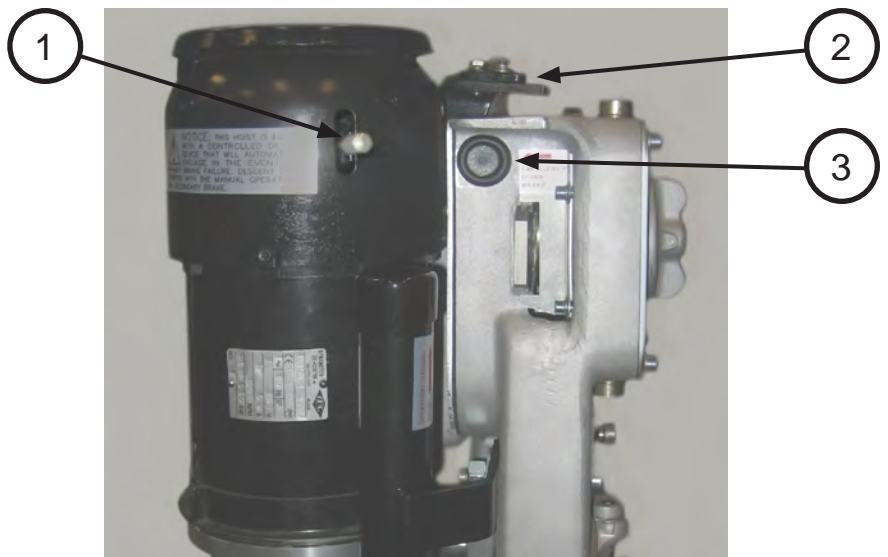

1. Emergency power cut-off button
2. Voltage Indicator
3. Electric motor with brake
4. Carrying Handle (Operator's Manual location)
5. Up / Down controls
6. Remote ready connection port
7. Electric control box
8. Gearbox
9. Power supply plug

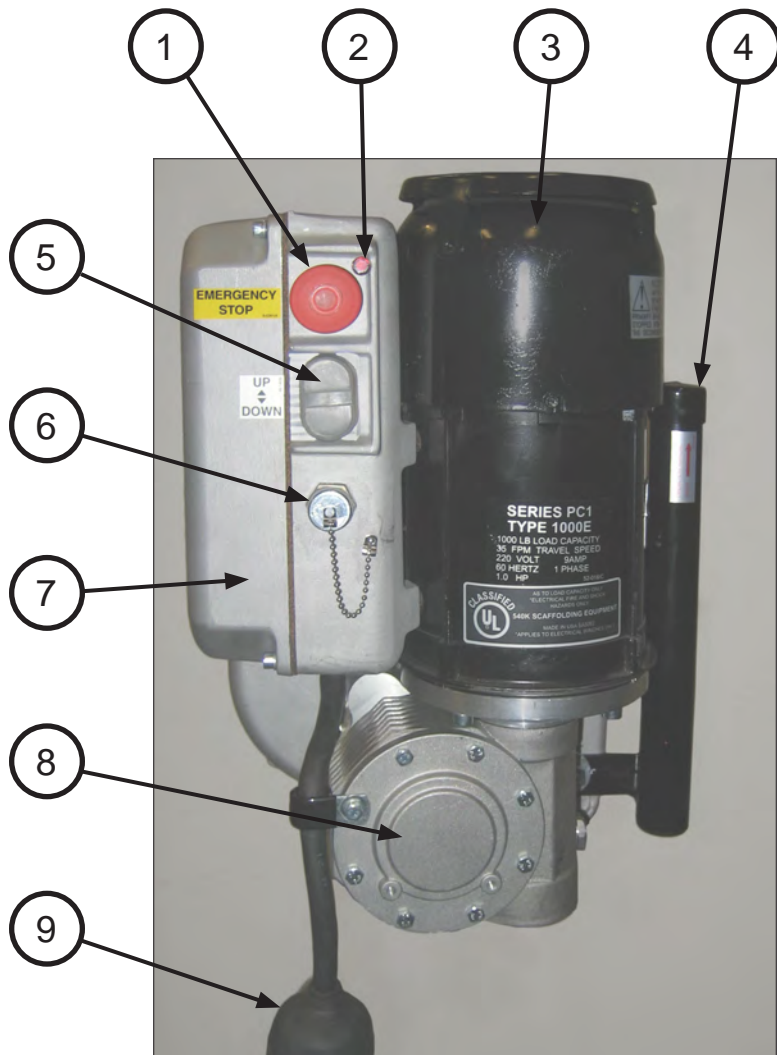

2.6 HOIST INSTALLATION

INSTALLING HOIST TO PLATFORM

<p> Follow the manufacturer's instructions for platform assembly. Attach the traction hoist stirrup bar to the stirrup of the platform. The hoist can be lifted into position by hand or by reeving the main suspension wire rope and powering the hoist into the stirrup.</p> <p>● Connect the hoist to the power supply. All electric hoists have a twist lock plug. The voltage indicator (item #2 on bottom of page 17) will illuminate when the hoist is receiving power. The electric supply must have sufficient capacity and the circuit breakers must be properly rated.</p>	
<h2>CAUTION</h2>	<p>● ▲ The electric supply must have sufficient capacity, and the circuit breakers must be properly rated according to General Specifications on page 6.</p>
<h2 style="text-align: center;">NOTE</h2> <p>▲ = Inspect</p> <p>● = Verify</p> <p> = Perform process</p>	<ul style="list-style-type: none"> ■ The voltage loss for 100ft (30.5m) of 10/3 electrical cable is 2 volts for each hoist used. <p>If lift-off is sluggish, determine the voltage at the motors when running. Voltage must be between 177-228 VAC.</p> <p>If the voltage is lower than 177 VAC when running:</p> <ul style="list-style-type: none"> ■ Increase voltage with a booster transformer at the power source when voltage is low OR, ■ Use larger gauge or separate electrical cables to each hoist to improve voltage supply. ■ Do not start both hoists at the same time to insure better hoist performance. Always maintain a level platform.

LAYING DOWN THE PC1 HOIST

When the platform is not in use and resting on a safe landing surface, it is important to lay the hoist down inside of the platform. Also, if the platform has to be moved and the hoist will remain attached during the move, it is important to lay the hoist down inside of the platform.

Laying the hoist down inside of the platform lowers the center of gravity to make the platform more stable to move. Doing this helps avoid injuries to users who move a platform with an attached hoist. There are two general methods to lay down the hoist prior to movement of equipment.

While the platform is on a safe landing surface, disconnect the hoist from its stirrup mount. Whether the hoist is in an “A-Frame” stirrup, walk-through, or some other version stirrup, it is important to either remove the hoist from the stirrup or lay the entire hoist-stirrup assembly down. This lowers the center of gravity of the platform and makes it more stable to move.

Hoists mounted to “A-Frame” stirrups can be laid down inside of the platform by following the steps below:

Un-Locked Stirrup Bar Position

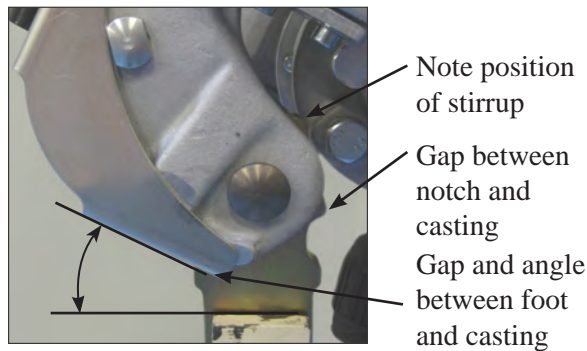

Locked Stirrup Bar Position

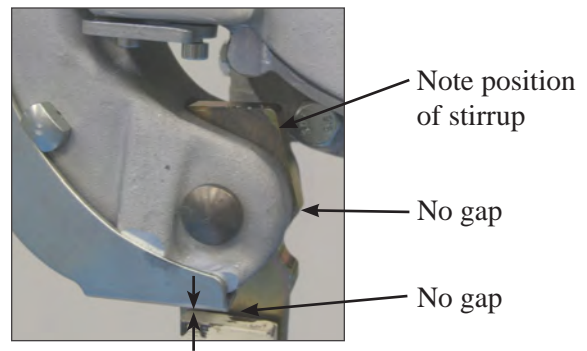

WARNING

If the platform is moved with a hoist in the Un-Locked Stirrup Bar Position, it is possible that the hoist may fall over and may result in SERIOUS INJURY.

Locked Stirrup Bar Position can be identified from the photos above. The hoist **WILL NOT PIVOT** at the connection point to the stirrup.

Un-Locked Stirrup Bar Position can be identified from the photos above and is proven by the fact that the hoist **WILL PIVOT** at the connection point to the stirrup.



Keep downward pressure on hoist- stirrup connection while laying hoist down to maintain locked connection.

REEVING MAIN SUSPENSION WIRE

- Make sure the access door and diverter cover are fully closed and fastened. The traction sheave must be fully inboard.
- Lift the slack rope lever to a vertical position.
- Insert the main suspension wire rope bullet through the slack rope lever inlet guide approximately 15" (38 cm). Operate the hoist in the ↑ UP direction while pushing the rope into the hoist.
- Make sure the wire rope runs freely through the tail line guide.

Slack rope lever

Inlet guide

Access door

Door latches

Traction sheave cover

Diverter cover

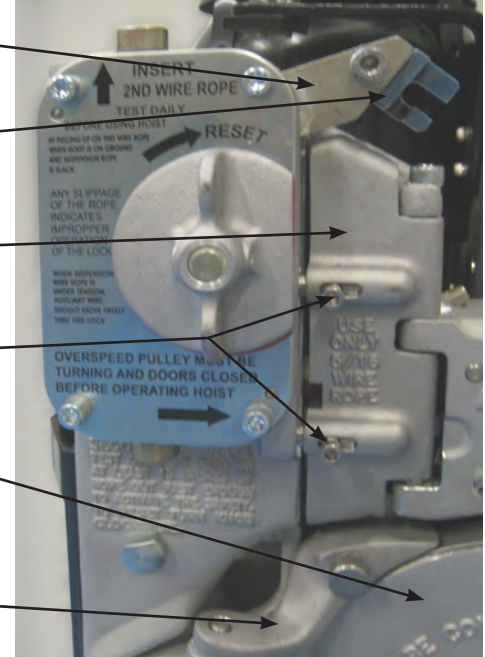

Access Door

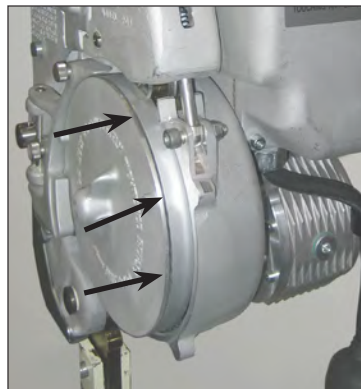

Closed Cover and Traction Sheave

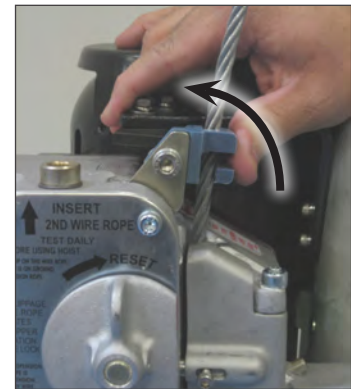

Slack Rope Lever

BREECH LOADING WIRE ROPE

■ Open the access door by sliding the (2) spring loaded pins from left to right at the same time.





■ Open the diverter cover by loosening the two knurled thumb screws. Swing the cover open.

NOTE: The next two steps require that the hoist is standing upright in a stirrup mount.

■ Push down on the electrical box until the rollers clear the traction sheave v-groove.

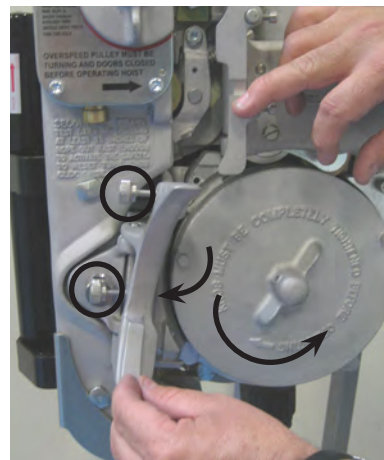
■ Turn the sheave guard counter-clockwise until the v-groove is exposed,



 Rotate the main suspension wire rope into the slack rope inlet guide.

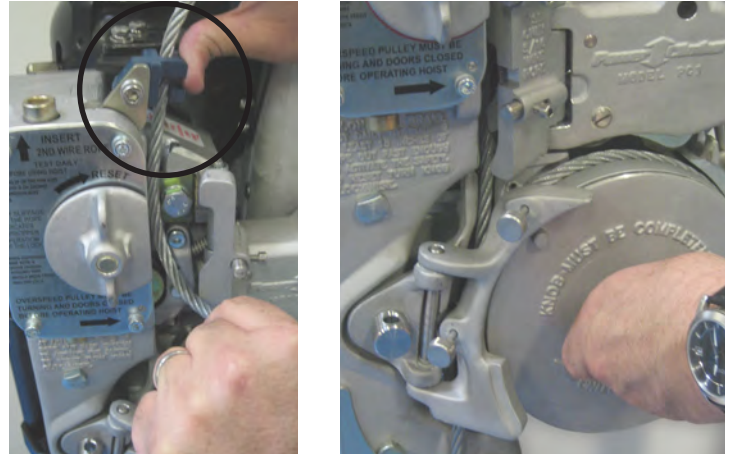

 Retract the overspeed tension assembly and push the wire rope between the overspeed sensor wheel and the overspeed tension assembly. Reeve the main suspension wire rope under and around the traction sheave, into the v-groove.



 Insert the main suspension wire rope into the tail line wire plate.



■ After the wire rope has been completely breech loaded into the hoist, push down on Electrical Box while turning the sheave guard clockwise until the sheave stops. The wire rope should be directly under the two traction rollers.

■ Close the diverter cover and screw in the knurled thumb screws to retain the door in a closed position.

■ **●** Close the access door in Step 1 and the hoist will be breech loaded.

■ Breech unloading can be done when no load is on the hoist by reversing these instructions.

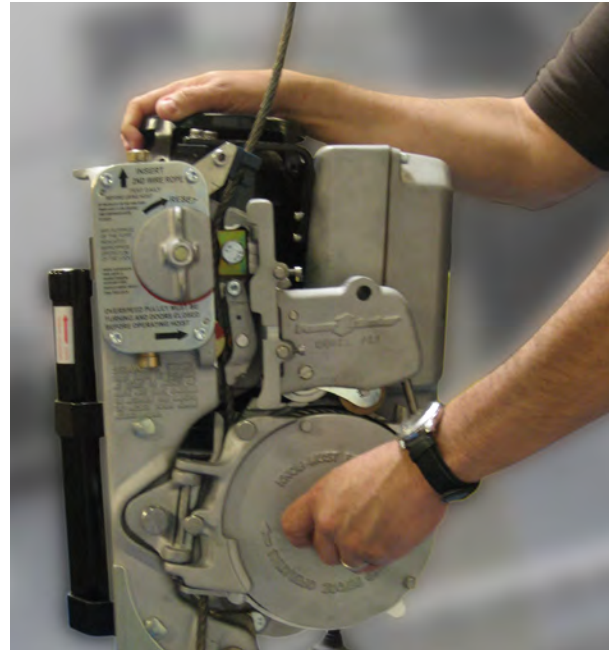

REEVING SECONDARY WIRE ROPE (OPTIONAL)

■ With a load on the main suspension wire rope (or while manually lifting the slack rope lever) insert the second wire rope into the inlet guide of the auxiliary slack rope brake.

■ Pushing the slack rope lever to the vertical position releases the auxiliary slack rope brake jaws. This allows the second wire rope to pass through the brake housing.

■ Attach a 25 lb (11.3 kg). weight to the end of the secondary wire rope to assist secondary rope travel.



▲ = Inspect

● = Verify

■ = Perform process

3.0 SAFETY INSTRUCTIONS

3.1 DAILY TESTS







WARNING

Perform all daily tests to ensure correct operation! Do not use the hoist for lifting until you have successfully completed the daily tests.

The following tests must be performed at the start of each work shift. If the hoist fails any test, DO NOT use it until it is repaired. Refer to the pictures on pages 15-16 to identify components. All tests are performed at or near ground level.

TESTING OVERSPEED BRAKE

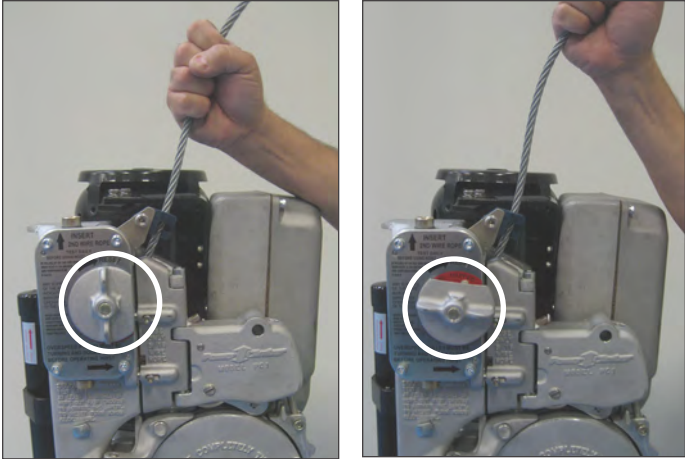
<p>  While powering the hoist ↑ UP and ↓ DOWN approximately 3 feet (1m), look through the overspeed inspection port to view that the overspeed roller (with red stripe) is turning.</p>	 
<p> Dereeve the wire rope.</p> <ol style="list-style-type: none"> 1. Re-insert the rope about 12 inches (30 cm) into the hoist. 2. Holding the wire rope firmly, pull it out quickly. If the brake is working correctly, it will grab and hold the wire rope in less than 4 inches (10 cm). 3. Repeat this test at least 3 times. If the brake does not work correctly every time, return the hoist to your hoist supplier. DO NOT USE THIS HOIST. 	

4. Reset the overspeed brake. (Turn reset knob clockwise.)



Overspeed Brake has tripped.

TESTING OVERSPEED BRAKE TEST BUTTON

 Push the ↑UP control button and raise the platform approximately 3 feet.

 While pushing the ↓DOWN control button, push the Secondary Overspeed Brake Test button.

 The hoist should stop quickly.

 Release the no-power emergency descent lever to make sure the secondary overspeed brake has locked onto the suspension rope.

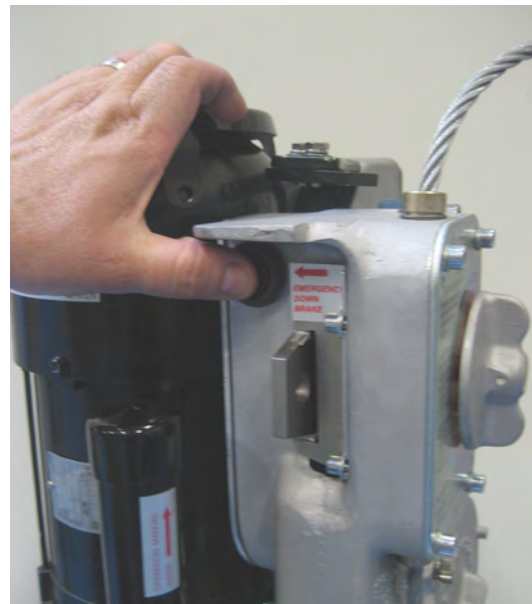

 = Inspect

 = Verify

 = Perform process

RESETTING THE OVERSPEED BRAKE

■ Power the hoist **↑UP** a few inches, at the same time turning the reset knob clockwise until the reset knob engages. If there is not enough traction to raise the hoist, pull downward on the tail line to increase traction.



TESTING THE EMERGENCY STOP BUTTON

■ While running the hoist in either direction, press the red Emergency Stop Button.

● The hoist should not run in either direction.

■ ● To reset, turn button clockwise.



▲ = Inspect

● = Verify

■ = Perform process



TESTING THE CONTROLLED DESCENT FEATURE

-  Raise the hoist approximately 3 feet (0.9m).
-  Disconnect the power supply. During this test, or when you are actually using the controlled descent feature, **CAREFULLY** pull the Controlled Descent Lever, making sure that the hoist does not overspeed. The hoist should descend at a slow, controlled speed.



CAUTION

If the overspeed brake trips while doing this test, the controlled descent system is not working properly and the hoist should not be used.



WARNING

Always allow the hoist to come to a complete stop before changing direction. Failure to come to a complete stop may prevent the hoist from traveling in the opposite direction and could result in serious injury or death.

3.2 DAILY INSPECTION

<p>▲ Inspect:</p> <ul style="list-style-type: none"> • Wire rope • Power supply • Rigging • Platform • Hoist <p>● Verify all parts are present, in proper working order, and are not damaged.</p>	<p>● Bolts, nuts, and clamps must be well secured.</p> <p>Make sure hoist is secured to the stirrup with SAE Grade 5 fasteners and lock nuts are properly installed.</p>
<h3>NOTE</h3>	<p>▲ When using the hoist in a dirty environment that contains epoxy, paint, cement, sand blast residue, or corrosive material, inspect the operation of the secondary overspeed brake several times per day. Protective hoist covers are recommended in these environments. Contact your Power Climber dealer.</p> <p>▲ = Inspect ● = Verify ■ = Perform process</p>



4.0 HOIST OPERATIONS

WARNING

BEFORE operating this hoist, you must understand and follow the instructions in this manual. You must be properly trained, physically fit, and authorized to operate the hoist. Failure to comply with these instructions could result in serious injury or death.



SAFETY NOTES

- **DO NOT** operate the hoist if you hear unusual noises.
- **DO NOT** operate the hoist if adjustments or repairs seem necessary.
- **DO NOT** operate the hoist if any warning, operation, or capacity instructions are unclear, missing, illegible, or damaged.

Report any problems to your supervisor and also notify the next operator when changing shifts. Tag the hoist “DO NOT USE UNTIL REPAIRED.”





- **NEVER** operate an electric hoist or any electrical equipment in an explosive atmosphere. Explosive atmospheres exist around refineries, chemical plants, grain elevators, distilleries, inside of silos, mines, or around coal handling equipment. This is not a complete list. Consult an expert if you are in doubt about the safety of your immediate surroundings.

TESTING THE EMERGENCY STOP BUTTON

 For routine ↑UP travel or ↓DOWN travel of the hoist, push the ↑UP or ↓DOWN control button. The buttons are spring loaded and return to the off position and apply the brake when released. If the hoist does not stop right away, press the Emergency Stop and the Overspeed brake test button.

 Unplug the electric supply plug from the power source.



 = Inspect

 = Verify

 =Perform process

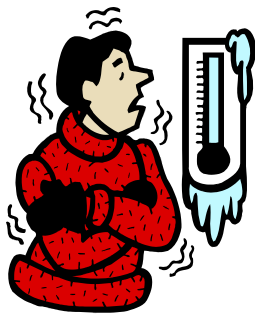

4.1 COLD WEATHER OPERATION

<ul style="list-style-type: none"> <input type="checkbox"/> When operating the hoist in cold weather, test the secondary overspeed brake frequently. <input type="checkbox"/> <input type="triangle-up"/> Make sure it is not frozen. If the brake does not stop the hoist, DO NOT USE the hoist until the brake has been thawed, dried, and is in proper working condition. <input type="checkbox"/> Thaw out the brake by blowing ducted dry heat (150°F / 65.6° C max) on the brake area. This can be done with an ordinary hair dryer. <p> <input type="triangle-up"/> = Inspect <input type="circle"/> = Verify <input type="checkbox"/> = Perform process </p>	<div style="text-align: center;">  </div> <ul style="list-style-type: none"> <input type="checkbox"/> DO NOT USE open flame on the unit. <input type="circle"/> If the unit will not operate properly after thawing, DO NOT USE. If the hoist will not climb or descend during these tests, do not use the hoist unless this is corrected during the thaw out process. <input type="checkbox"/> Return the hoist to your hoist supplier.
 <h3 style="color: red; margin: 0;">WARNING</h3>	<p>Be extremely careful when using the hoist in freezing temperatures. Frequently check for normal hoist operation. All tests must be done within 3ft (1m) of ground level.</p>





4.2 DEREEVING

REMOVING THE MAIN SUSPENSION WIRE ROPE



<ul style="list-style-type: none"> <input type="circle"/> Make sure that the platform is properly supported on a stable surface before putting slack on the main suspension wire rope to prevent hoists and platform from tipping and causing injury. <input type="checkbox"/> While on the ground, the main suspension line will wind out of the hoist when the ↓ DOWN control button is pushed. 	<ul style="list-style-type: none"> <input type="checkbox"/> You may have to help remove the last 15 inches (38 cm) of wire rope. <input type="checkbox"/> Grab the wire rope above the rope insertion point, hold the overspeed brake reset knob in the “reset” position, and slowly pull the main suspension wire rope out of the hoist.
---	---

REMOVING THE SECONDARY WIRE ROPE (OPTIONAL)

Make sure that the platform is properly supported on a stable surface before putting slack on the main suspension wire rope to prevent hoists and platform from tipping and causing injury.

-   There should be no slack on the main suspension wire rope.
-  Before the main suspension line has been removed from the hoist, remove the counterweight from the end of the secondary wire rope.
-  The auxiliary slack rope brake jaws must be held open. Pull the rope up through the auxiliary slack rope brake housing. It is easiest to remove the second wire rope while the hoist is suspended just above the ground (before dereeving the main suspension wire rope). The jaws can also be held open by manually pushing the slack rope lever to the upright position.

If you are removing both wire ropes from the hoist on a stable surface, you must remove the secondary wire rope before removing the main suspension wire rope.

-  = Inspect
-  = Verify
-  = Perform process



4.3 MAINTENANCE

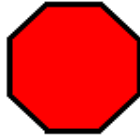



























<p> = Inspect = Verify = Perform process </p>	<p> The hoist should be returned to a Power Climber dealer for periodic maintenance at least once a year from date of being placed into service. </p> <p> More frequent service may be required if the hoist is subjected to dirty environments. </p> <p> If the hoist fails any inspection or operation, it should be returned for service. </p>
--	---

4.4 TROUBLESHOOTING







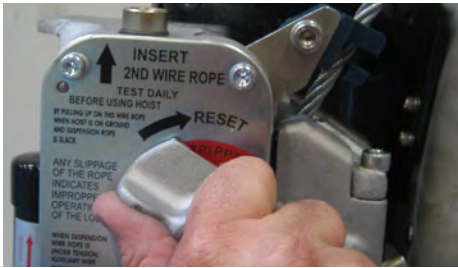

STOP! Read all Troubleshooting Guidelines before attempting any solution.

Problem	Possible cause and solution
<p>1. No power to platform. (Voltage indicator light is OFF.)</p> <p>Consult your supervisor to correct problems.</p> <p> = Inspect = Verify = Perform process </p>	<p> Power at the junction box is off. </p> <p> Circuit breaker is tripped. </p> <p> Plugs are not connected. Check hoist, yoke, power cord, and power source. </p> <p> Damaged electrical cord. </p> <p> Power indicator light is burnt out. </p> <p> Not enough power is being supplied to hoist. </p> <p> If the indicator light comes back on after 30 seconds, thermal (TH2) has tripped due to excessive amperage. Consult with your supervisor and check for low voltage. </p>

<p>2. Hoist does not run. ( Voltage indicator light is ON.)</p>	<ul style="list-style-type: none">   If the motor is hot, motor thermal overload protection may have tripped. Allow motor to cool and see if it resets. This may take 30 minutes or more.  Frequent stops and starts, high outside temperature, a dragging brake, or overloading can cause the motor to heat up.
	<ul style="list-style-type: none">  Increase hand pressure on the wire rope while pushing the ↑UP button.  Take the wire rope out, turn it 180° and put it back into the hoist while pushing the ↑ UP button.   If the bullet is poor bullet, prepare a new end.   If the end of wire rope is bent or kinked, prepare a new end.   If dirt or other material is obstructing inside the hoist, clean out with air or flush with water.
<p>4. Motor runs normally but hoist will not lift.</p> <div style="text-align: center;"></div>	<ul style="list-style-type: none">  Make sure that the bullet end of the wire rope has come out of the wire rope exit spring.   Inspect the wire rope for damage or wear and replace as necessary. <p style="text-align: center;"> WIRE ROPE MAY BE JAMMED. DO NOT CONTINUE TO OPERATE. CALL YOUR SUPERVISOR. </p>
<p>5. Hoist hums, starts slowly, and is sluggish.</p> <ul style="list-style-type: none">  = Inspect  = Verify  =Perform process 	<ul style="list-style-type: none">  Check for correct run voltage. Correct as necessary.  Run separate cords for each hoist.  Use shorter cords.  Use short cord with larger wires.  Add a booster transformer at the power source.

<p>6. Overspeed flywheel does not turn while hoist moves ↑UP or ↓DOWN.</p> <p>▲ = Inspect ● = Verify ■ = Perform process</p>	<p>● If you are in the air, push the Overspeed Brake Test button and wait to be rescued.</p> <p> DO NOT USE UNTIL THIS HAS BEEN REPAIRED.</p> <p>● If you are on the ground, check and correct the following as needed</p> <p>■ ▲ Obstructions such as dirt or other materials</p> <p>▲ Wire rope may be worn out. Call your supervisor.</p> <p>▲ Hoist parts may be worn out. Call your supervisor.</p>
<p>7. Cannot reset the Overspeed brake reset knob.</p> <p>WARNING</p>	<p>● ▲ DO NOT RESET THE OVERSPEED UNTIL:</p> <ul style="list-style-type: none"> • You have determined that there is enough wire rope to reach a safe landing surface. • You know that the wire rope is not jammed in the hoist. • You know the reason that the overspeed has been tripped and there is no danger when it is reset. <p>Power the hoist ↑UP a few inches, at the same time turning the reset knob clockwise until the reset knob engages.</p> 
<p>8. Hoist does not stop immediately when the ↓DOWN button is released.</p>	<p>■ Push in the Overspeed Brake Test button and wait to be rescued.</p> <p>■ Call your supervisor.</p> <p>■ Return the hoist to be serviced by a Power Climber dealer.</p>

 <p>9. You hear unusual noises coming from the hoist.</p>	<p>If you are in the air:</p> <ul style="list-style-type: none"> <input type="checkbox"/> Push the EMERGENCY STOP button. <input type="checkbox"/> Push the Overspeed brake test button and wait to be rescued. <input type="checkbox"/> Unplug the hoist from the power cord. <input type="checkbox"/> Call your supervisor. <input type="checkbox"/> Return the hoist to be serviced by a Power Climber dealer.
<p>WARNING</p>	 <p>You may have a rope jam. Any attempt to operate the hoist could cause serious injury or death.</p>
<ul style="list-style-type: none">  = Inspect  = Verify <input type="checkbox"/> = Perform process 	<p>If you are on the ground:</p> <ul style="list-style-type: none"> <input type="checkbox"/>  Check for damaged wire rope and replace as needed. <input type="checkbox"/>  Check for dirt on the wire rope and clean/ lubricate as needed. <input type="checkbox"/>  Check the hoist for visible signs of damage, call supervisor and return hoist for service.

4.5 HOIST LABELS

FRONT

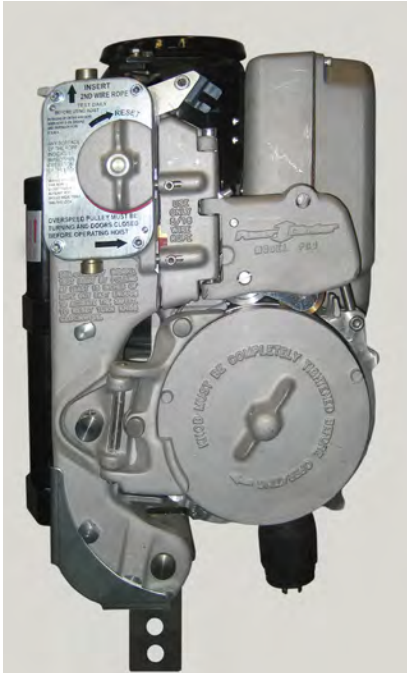

BACK



SIDE



● Verify hoist labels appear as they do in photos. If you notice any missing labels, please contact your hoist dealer.

CODE OF SAFE PRACTICES FOR ADJUSTABLE SUSPENDED SCAFFOLDS

CO-DEVELOPED BY THE **SCAFFOLDING, SHORING & FORMING INSTITUTE (SSFI)**
and THE **SCAFFOLD AND ACCESS INDUSTRY ASSOCIATION, INC. (SAIA)**

It shall be the responsibility of all users to read and comply with the following common sense guidelines which are designed to promote safety in the erecting, dismantling and use of adjustable suspended scaffolds. These guidelines do not purport to be all-inclusive nor to supplant or replace other additional safety and precautionary measures. If these guidelines conflict with any local, provincial, state, federal or other government regulations, the regulations shall supersede these guidelines and it shall be the responsibility of each user to comply therewith.

I. GENERAL GUIDELINES

- A. POST THESE SAFE PRACTICES** in a conspicuous place. Be sure that all persons who erect, use, relocate, or dismantle adjustable suspended scaffold systems are fully aware of them. Use them in tool box safety meetings.
- B. FOLLOW ALL EQUIPMENT MANUFACTURER'S RECOMMENDATIONS** as well as all local, provincial, state and federal codes, ordinances and regulations relating to adjustable suspended scaffold systems.
- C. SURVEY THE JOB SITE.** A competent person shall survey the job site for hazards such as exposed electrical wires, obstructions and, unguarded roof edges or openings.
- D. INSPECT ALL EQUIPMENT BEFORE EACH USE.** Never use any equipment that is damaged or defective in any way. Mark it or tag it as damaged or defective and remove it from the job site.
- E. ERECT AND DISMANTLE ADJUSTABLE SUSPENDED SCAFFOLD EQUIPMENT** in accordance with the design and/or manufacturer's recommendations.
- F. DO NOT ERECT, DISMANTLE OR ALTER ADJUSTABLE SUSPENDED SCAFFOLD SYSTEMS** except under the supervision of a competent person.
- G. DO NOT ABUSE OR MISUSE ADJUSTABLE SUSPENDED SCAFFOLD EQUIPMENT.** Never overload any equipment.
- H. ERECTED ADJUSTABLE SUSPENDED SCAFFOLDS ARE TO BE INSPECTED REGULARLY** by the user to be sure that they are maintained in a safe condition. Stop work and report any unsafe condition to your supervisor.
- I. NEVER TAKE CHANCES! IF IN DOUBT REGARDING THE SAFETY OR USE OF ADJUSTABLE SUSPENDED SCAFFOLDS, CONSULT A QUALIFIED PERSON.**
- J. NEVER USE ADJUSTABLE SUSPENDED SCAFFOLD EQUIPMENT FOR PURPOSES FOR WHICH IT WAS NOT INTENDED.**
- K. A COMPETENT PERSON SHALL CONSIDER STOPPING WORK WHEN WIND SPEED EXCEEDS 25 MPH FOR 2-POINT ADJUSTABLE SUSPENDED SCAFFOLDS OR 20 MPH FOR SINGLE POINT SUSPENSION.** If materials on a platform create a sail effect, stopping work at lower wind speeds must be considered.

- L. ADJUSTABLE SUSPENDED SCAFFOLD SYSTEMS** are to be installed and used in accordance with the manufacturer's recommended procedures.
- M. ADJUSTABLE SUSPENDED PLATFORMS MUST NEVER BE OPERATED NEAR LIVE POWER LINES** unless proper precautions are taken. Contact the power service provider for advice.
- N. ALWAYS UTILIZE FALL ARREST EQUIPMENT** when working on adjustable suspended scaffolds or when working near unguarded edges.
- O. DO NOT WORK FROM, INSTALL OR MOVE ADJUSTABLE SUSPENDED SCAFFOLDS** if you are sick or impaired in any way.
- P. DO NOT WORK ON ADJUSTABLE SUSPENDED SCAFFOLDS** when under the influence of alcohol or drugs.
- Q. DEBRIS SHOULD NOT BE STORED OR ALLOWED TO ACCUMULATE ON A PLATFORM.**
- R. INDEPENDENT ADJUSTABLE SUSPENDED SCAFFOLDS ARE TO BE POSITIONED SO AS TO AVOID OVERLAPPING OR POSSIBLE INTERFERENCE FROM ANOTHER SCAFFOLD.**

II. GUIDELINES FOR ERECTION AND USE OF ADJUSTABLE SUSPENDED SCAFFOLD SYSTEMS

A. RIGGING:

- 1. UTILIZE FALL PROTECTION EQUIPMENT** when rigging near unguarded edges.
- 2. SUPPORTING DEVICES** must be capable of supporting the hoist rated load with a safety factor of 4.
- 3. ALL OVERHEAD RIGGING** must be secured from unwanted movement in any direction.
- 4. COUNTERWEIGHTS USED WITH OUTRIGGER BEAMS** must be of a non-flowable material and must be secured to the beam to prevent accidental displacement.
- 5. OUTRIGGER BEAMS THAT DO NOT USE COUNTERWEIGHTS** must be installed and secured to the roof structure with bolts or other direct connections. Direct connections shall be evaluated by a competent person.
- 6. TIE BACK ALL TRANSPORTABLE RIGGING DEVICES.** Tieback shall be equivalent in strength to the suspension ropes.
- 7. INSTALL TIEBACKS AT RIGHT ANGLES TO THE FACE OF THE BUILDING** and secure them without slack, to a suitable anchor capable of supporting the hoist rated load with a safety factor of 4.
- 8. IN THE EVENT THAT TIEBACKS CANNOT BE INSTALLED AT RIGHT ANGLES,** two tiebacks at opposing angles must be used to prevent movement.
- 9. RIG AND USE HOISTING MACHINES DIRECTLY UNDER THEIR SUSPENSION POINTS** to prevent movement or side loading.

B. WIRE ROPE AND HARDWARE:

- 1. USE ONLY WIRE ROPE AND ATTACHMENTS** specified by the hoisting machine manufacturer.
- 2. HANDLE WIRE ROPE WITH CARE.** Always use gloves.
- 3. COIL AND UNCOIL WIRE ROPE** in accordance with manufacturer's instructions in order to avoid kinking or damage.
- 4. ASSURE THAT THE WIRE ROPE IS LONG ENOUGH** to reach to the lowest possible landing.
- 5. CLEAN AND LUBRICATE WIRE ROPE** in accordance with the wire rope manufacturer's instructions.
- 6. INSPECT WIRE ROPE IN ACCORDANCE WITH MANUFACTURER'S INSTRUCTIONS. DO NOT USE WIRE ROPE THAT IS KINKED, BIRDCAGED, CORRODED, UNDERSIZED, OR DAMAGED IN ANY WAY.** Do not expose wire rope to fire, undue heat, corrosive atmosphere, electricity, chemicals or damage.
- 7. WIRE ROPES USED WITH TRACTION HOISTS MUST HAVE PREPARED ENDS.** Follow hoist manufacturer's recommendations.
- 8. USE THIMBLES AT ALL WIRE ROPE SUSPENSION TERMINATIONS.**
- 9. USE J-BOLT WIRE ROPE CLAMPS OR SWEDGE FITTINGS. DO NOT USE U-BOLT CLAMPS.**
- 10. TIGHTEN THE J-BOLT WIRE ROPE CLAMPS** in accordance with the manufacturer's instructions.

C. POWER SUPPLY FOR MOTORIZED EQUIPMENT:

- 1. USE PROPERLY GROUNDED ELECTRICAL POWER CORDS.** Protect them with circuit breakers.
- 2. USE POWER CORDS AND AIR HOSES OF THE PROPER SIZE THAT ARE LONG ENOUGH** for the application.
- 3. POWER CORD AND AIR HOSE CONNECTIONS MUST BE RESTRAINED** to prevent separation.
- 4. USE STRAIN RELIEF DEVICES TO ATTACH POWER CORDS AND AIR SUPPLY HOSES THE PLATFORM,** to prevent them from separation.
- 5. PROTECT POWER CORDS AND AIR HOSES FROM SHARP EDGES.**
- 6. USE GFCI WITH POWER TOOLS.**

D. FALL ARREST EQUIPMENT:

- 1. EACH PERSON ON AN ADJUSTABLE SUSPENDED SCAFFOLD** must be attached to an independent fall arrest system.

2. **EACH VERTICAL LIFELINE SHALL BE ATTACHED IN ACCORDANCE WITH THE MANUFACTURER'S INSTRUCTIONS** to a separate anchorage capable of supporting a minimum of 5000 pounds (2267 kg) or an anchorage designed by a qualified person.
3. **DO NOT WRAP LIFELINES AROUND STRUCTURAL MEMBERS** unless lifelines are protected and a suitable anchorage connection is used.
4. **PROTECT LIFELINES AT SHARP CORNERS AND EDGES** to prevent chafing.
5. **RIG FALL ARREST SYSTEMS** to minimize free fall.
6. **INSTALL VERTICAL LIFELINES SO THEY HANG FREELY.**
7. **USE LIFELINES** that are compatible with the rope grab.
8. **INSTALL ROPE GRAB IN ACCORDANCE WITH THE MANUFACTURER'S RECOMMENDATIONS.** Rope grab must be properly oriented.
9. **KEEP ROPE GRAB POSITIONED ABOVE YOUR HEAD.**
10. **UTILIZE FULL BODY HARNESSSES** of the proper size and fit.
11. **UTILIZE SHOCK-ABSORBING LANYARD** attached to the D-ring at the center of your back between the shoulder blades.
12. **INSPECT FALL PROTECTION ANCHORAGE/EQUIPMENT BEFORE EACH USE.** Consult the fall protection supplier for inspection procedures.
13. **WHEN A SECONDARY WIRE ROPE SYSTEM IS USED** instead of a vertical lifeline, attach the lanyard to a horizontal lifeline or an approved platform anchor.

E. DURING USE:

1. **USE ALL EQUIPMENT AND ALL DEVICES** in accordance with the manufacturer's instructions.
2. **DO NOT OVERLOAD OR MODIFY EQUIPMENT.**
3. **INSPECT ALL EQUIPMENT INCLUDING HOISTS, PLATFORM, AND RIGGING** before each use.
4. **INSPECT WIRE ROPE BEFORE AND DURING USE.**
5. **USE CARE TO PREVENT DAMAGE TO EQUIPMENT.**
6. **CLEAN AND SERVICE EQUIPMENT REGULARLY.** Follow the manufacturers' recommendations.
7. **ALWAYS MAINTAIN AT LEAST (4) FOUR WRAPS OF WIRE ROPE ON DRUM TYPE HOISTS.**
8. **DO NOT CONNECT PLATFORMS** unless the installation was designed for that purpose.
9. **DO NOT MOVE ADJUSTABLE SUSPENDED SCAFFOLDS HORIZONTALLY** unless safe work practices are followed.

10. WHEN RIGGING FOR ANOTHER DROP assure sufficient wire rope is available before moving the suspended platform horizontally to the next location.

F. WELDING FROM SUSPENDED SCAFFOLDS REQUIRES SPECIAL TRAINING:

- 1. ASSURE PLATFORM IS GROUNDED TO THE STRUCTURE** using a grounding conductor.
- 2. INSULATE WIRE ROPE ABOVE AND BELOW THE PLATFORM.**
- 3. INSULATE WIRE ROPE AT SUSPENSION POINT AND ASSURE WIRE ROPE DOES NOT CONTACT THE STRUCTURE ALONG ITS ENTIRE LENGTH.**
- 4. PREVENT THE WIRE ROPE END FROM BECOMING GROUNDED.**
- 5. INSULATE EACH HOIST WITH A PROTECTIVE COVER.**
- 6. INSULATE TIE BACK WIRE ROPES AT THE CONNECTION POINTS.**

Since field conditions vary and are beyond the control of the SSFI and the SAIA, safe and proper use of adjustable suspended scaffolding is the sole responsibility of the user.

© Scaffolding, Shoring & Forming Institute, 1300 Sumner Ave., Cleveland, OH 44115;
© Scaffold and Access Industry Association, 400 Admiral Blvd., Kansas City, MO 64106,
(P) 816 595-4860; (F) 816 472-7765. www.scaffold.org

This document is the property of the SSFI and the SAIA.
Permission for reprinting this document is granted in the interest of safety.

Reprinting of this publication does not imply approval of product by or indicate membership in the Association.